

03

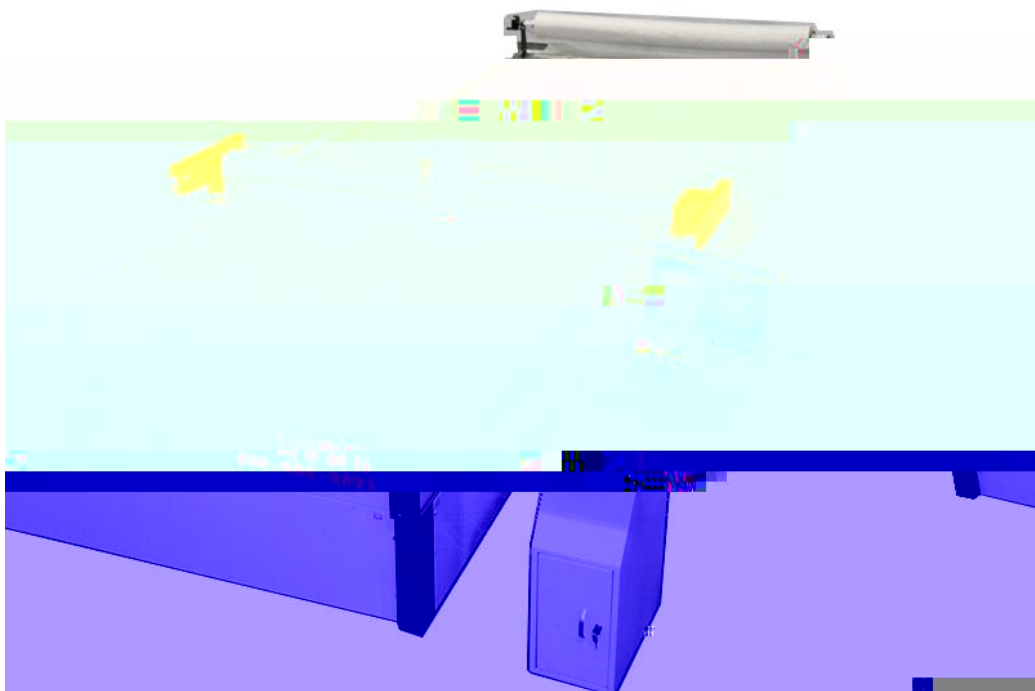





RJ	4
1-1		4
1-2		4
1-3		4
1-4		5
1-5		7
1-6		7
1-7		8
	
2-1		10
2-2		10
2-3		11
1		11
2		11
3		11
4		12
5		13
6		13
7		14
8		15
9		15
2-4		16
2-5		19
2-6		20
	20
	21
	
	23



.

.

.

.

.

.

.

.

.

.

.

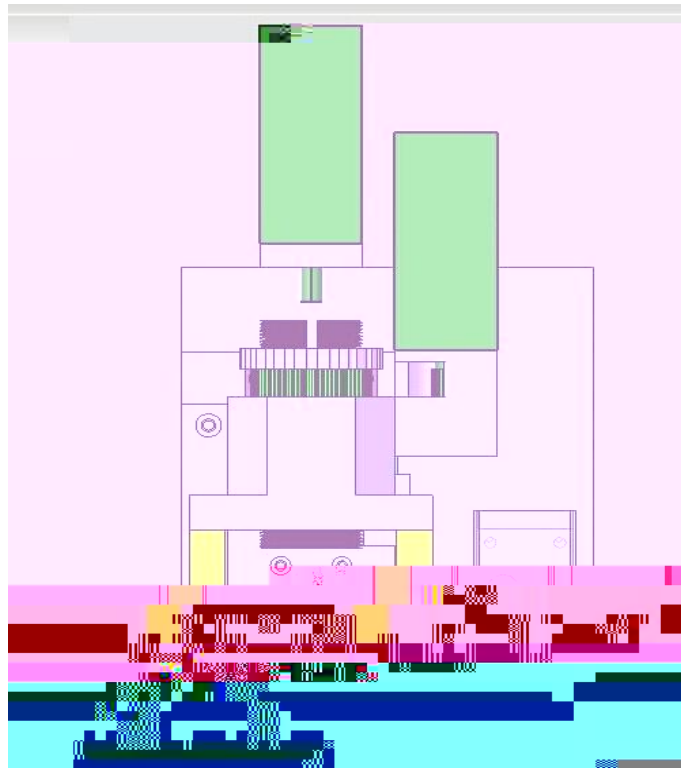

1-3

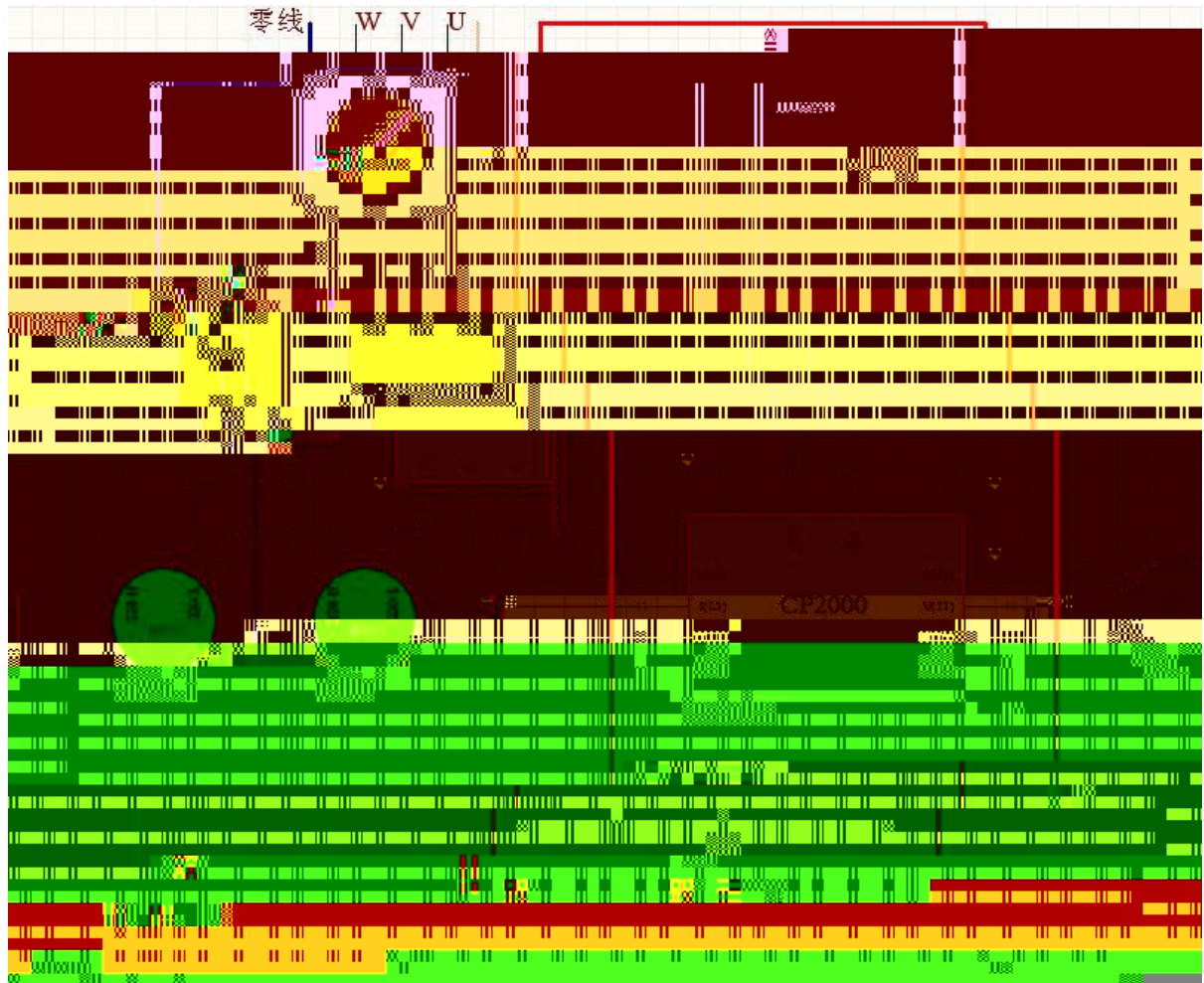

1-4

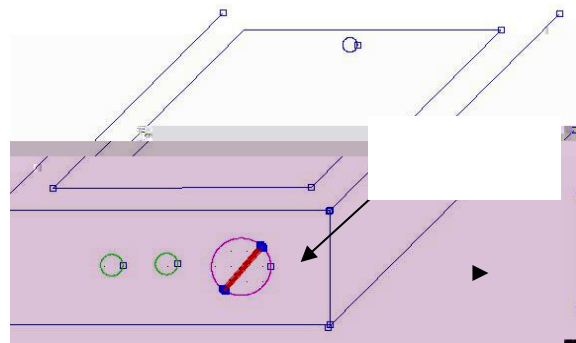



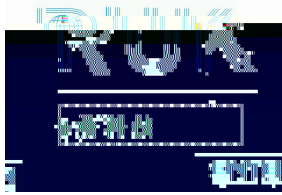

ENTER

2)

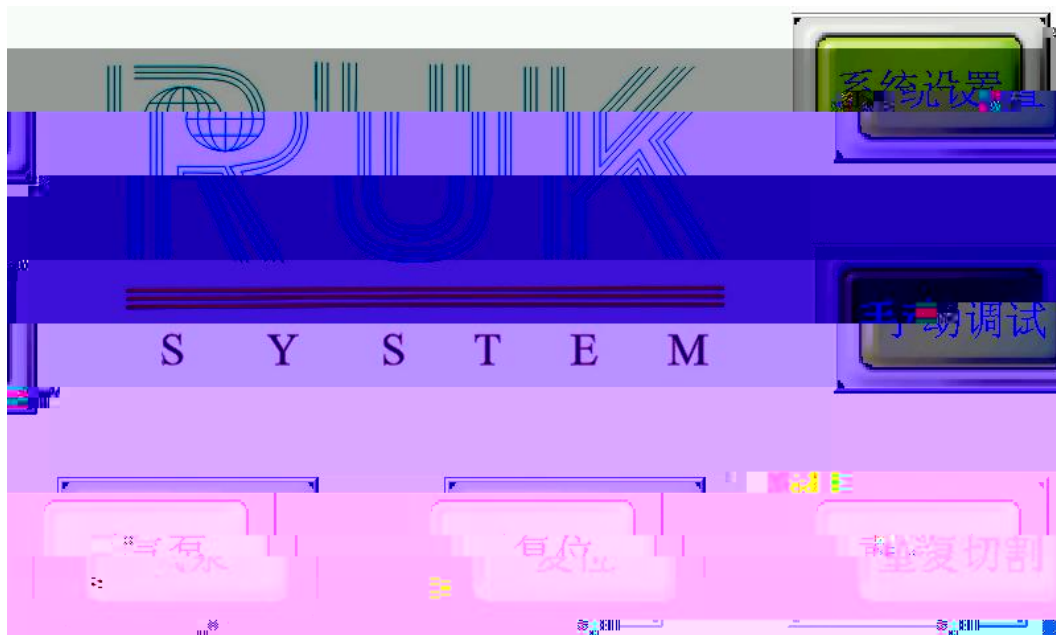

2-2

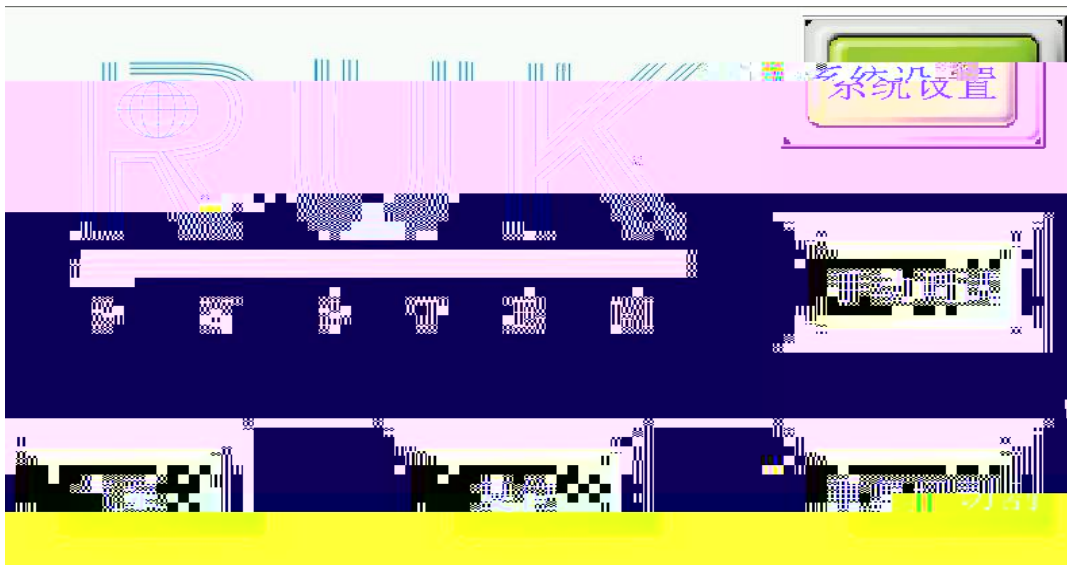

2- 3



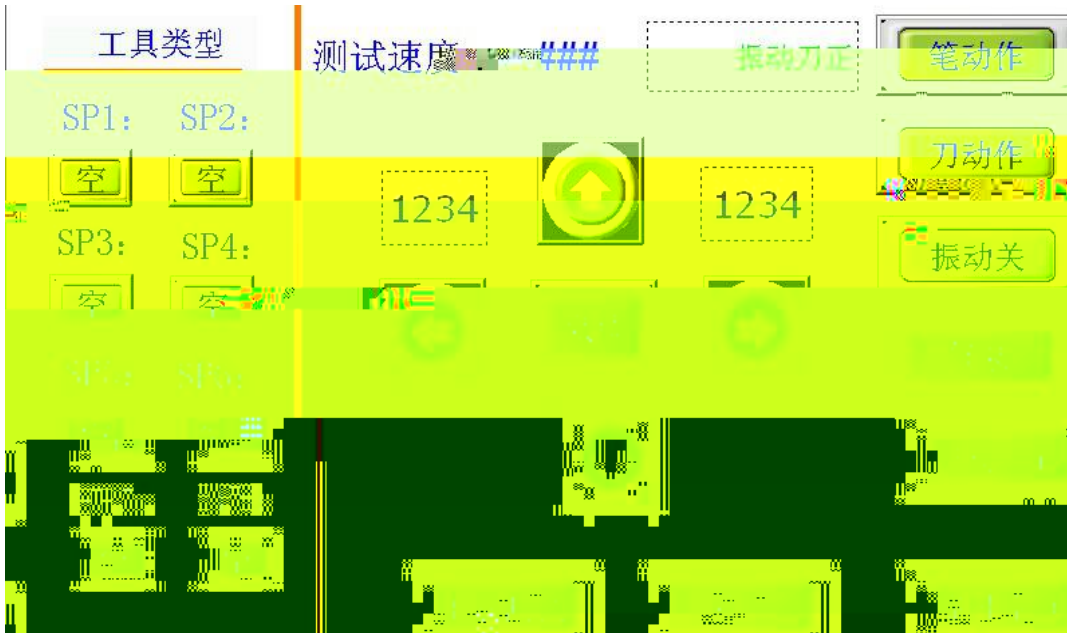

- 1
- 2
- 3



2- 4

- | | | | |
|---|--|--|-------|
| 1 | | | X" " |
| 2 | | | X" -" |



- 3   Y" +"
- 4   Y" -"
- 5 / /
- 6 ;
- 7 ;
- 8 X Y 1/10
- 9



2- 5

- 1   " " " "
- 2    
- 3 " "
- MM .
- 4
- 5



5

自动送布

自动滚动:

关

滚动放气:

关

夹皮带



1

2

3

4

5

6



2

7

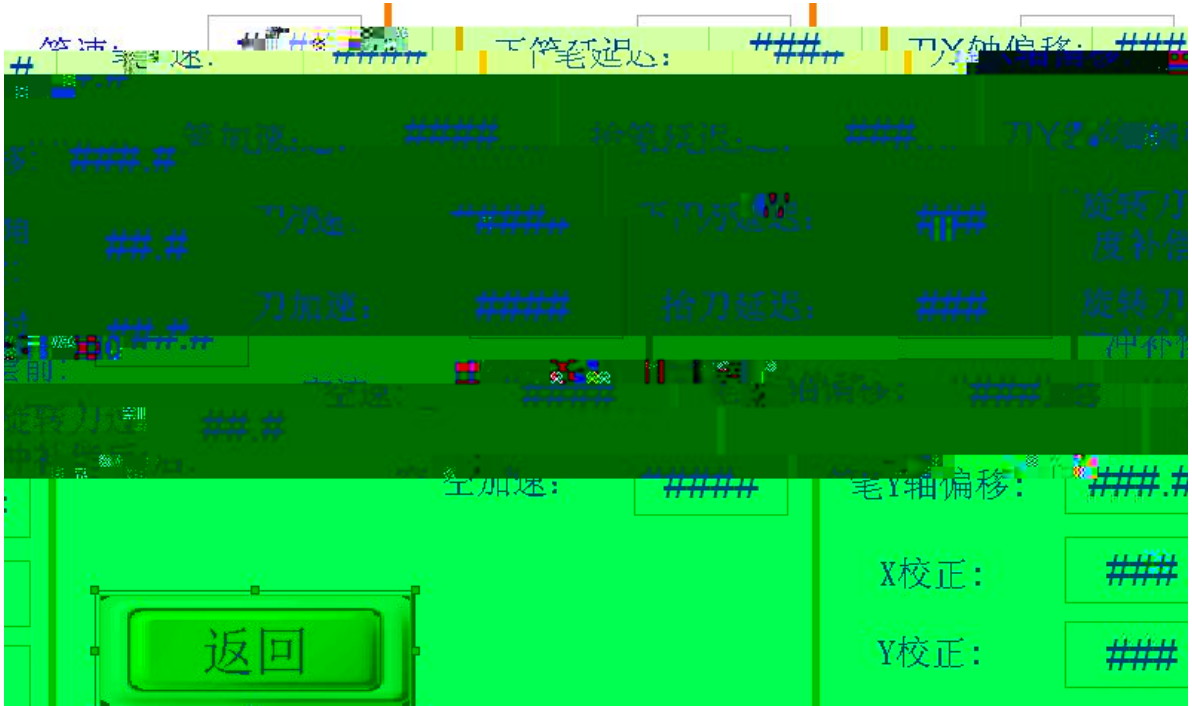

2-7

1

2

3

4

5

6

7

X X

8

Y Y

9

X X U

10

Y Y U

11

X X

12

Y Y

13

N

14

N

15

N

16

N

17

18

MM

19

MM

8



2-8

- 1
- 2
- 3
- 4
- 5
- 6
- 7
- 8

9

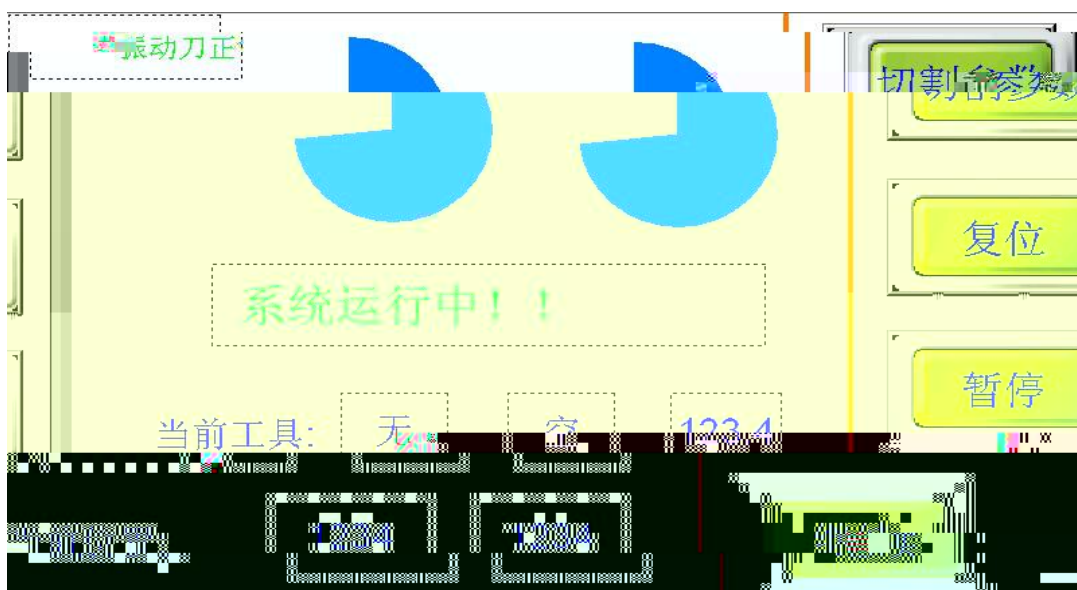

2-9



- 1
- 2
- 3
- 4
- 5 " "
- 6
- 10

切割参数

笔速: ##### 中间深度: ###.#

笔加速: "##### 全刀深度: ###.#

刀速: +##### 半刀深度: ###.#

刀加速: #####

空速: #####



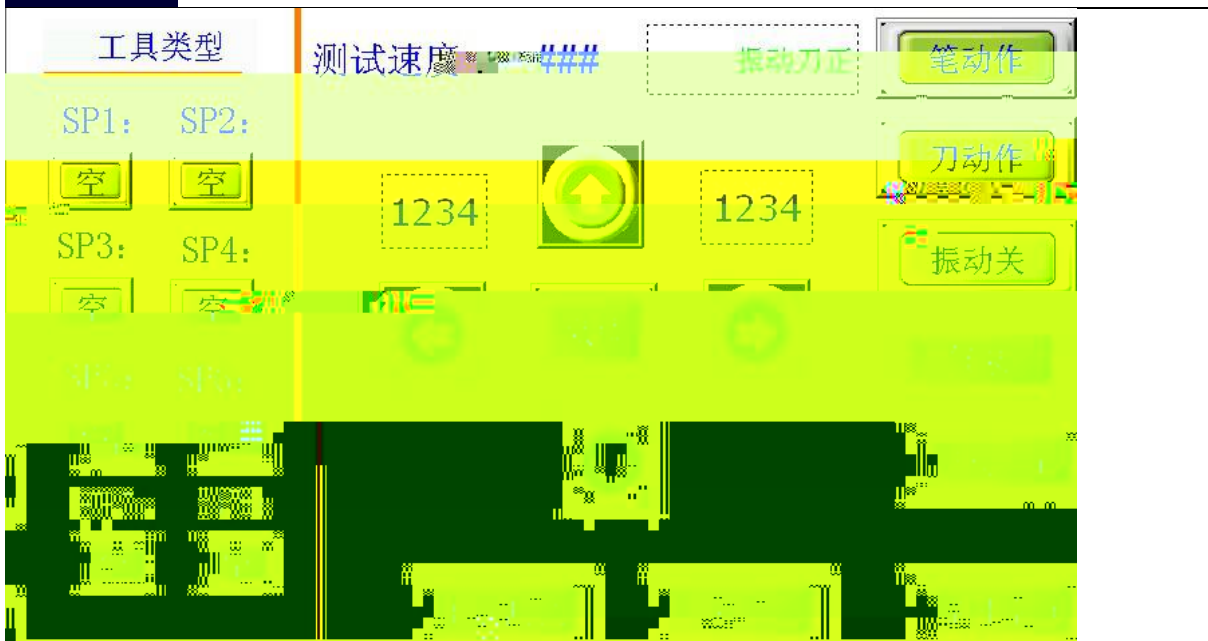

2- 11

2

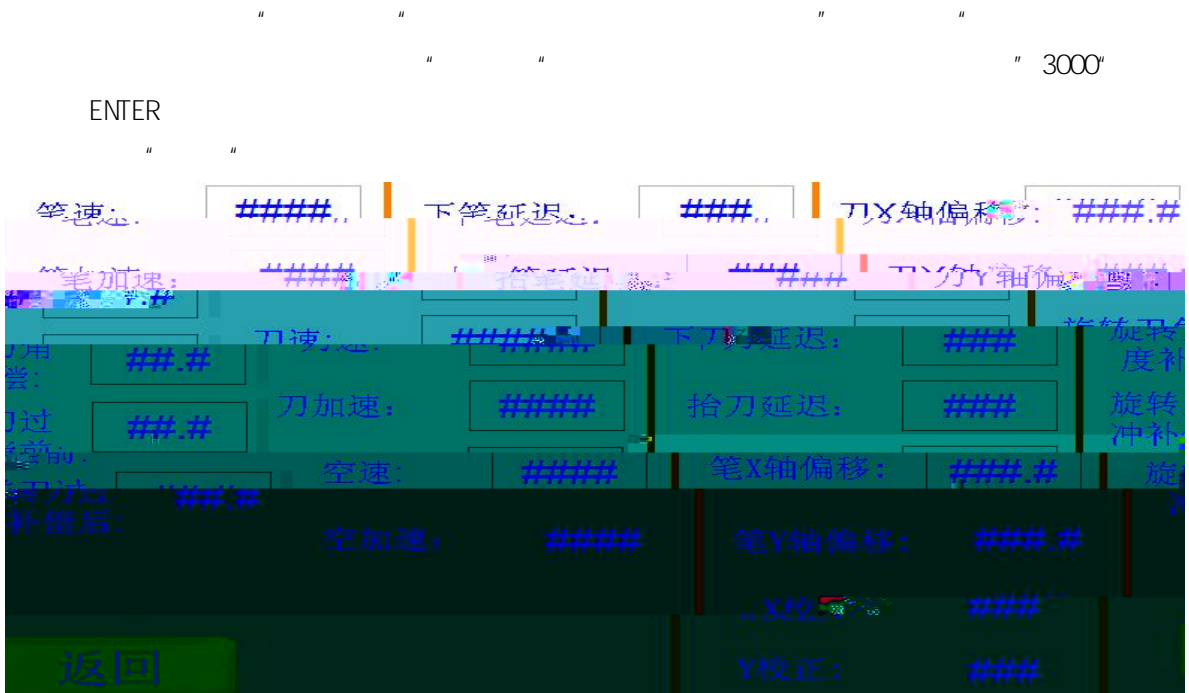

2- 12

3 Ethernet

Ethernet

- 1 " "
- 2 " " " "
- 3 IP IP " 192.168.0.26" IP
" 192.168.0.250"
- 4 Ethernet IP m

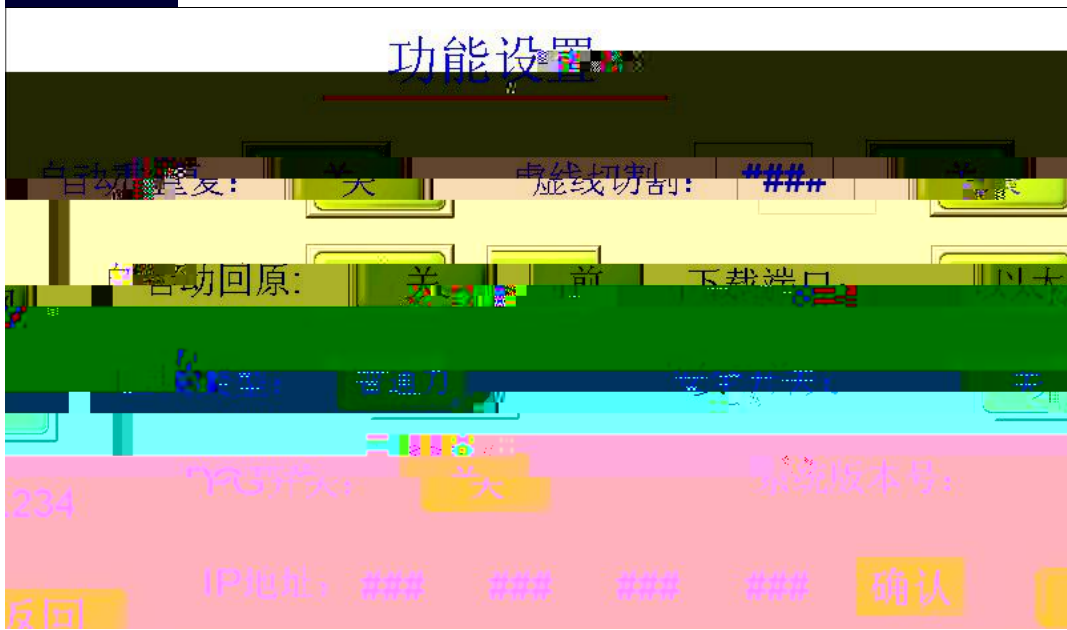

2-13

4

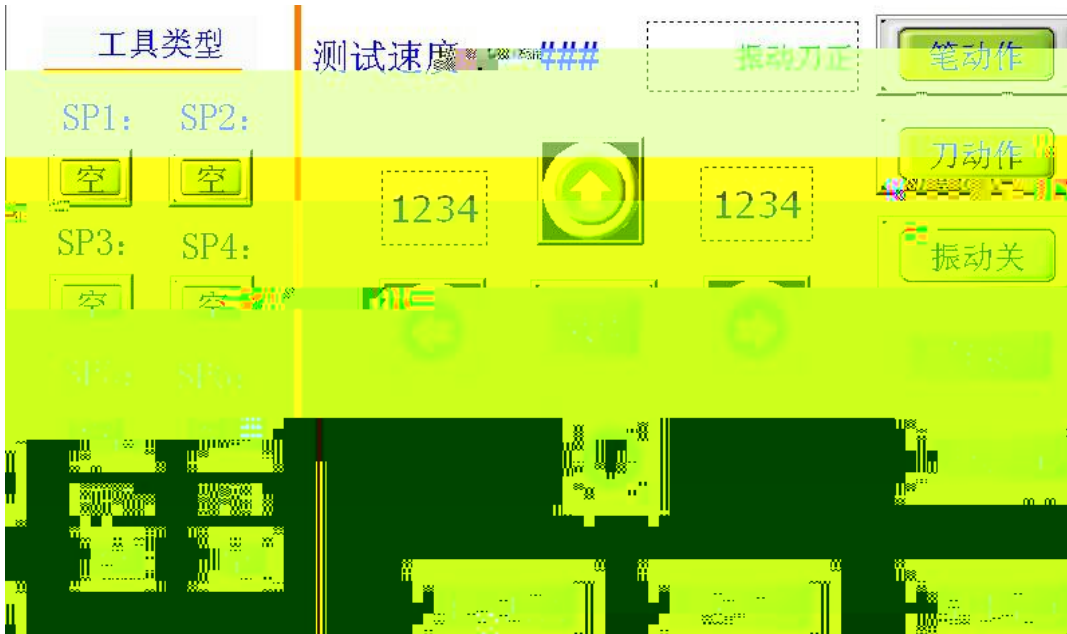

2-14

" " " X / " Y / "

" "

" "



2-5

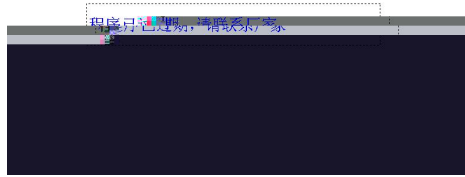

2-15

1)

"

"



2

"

"

ENTER

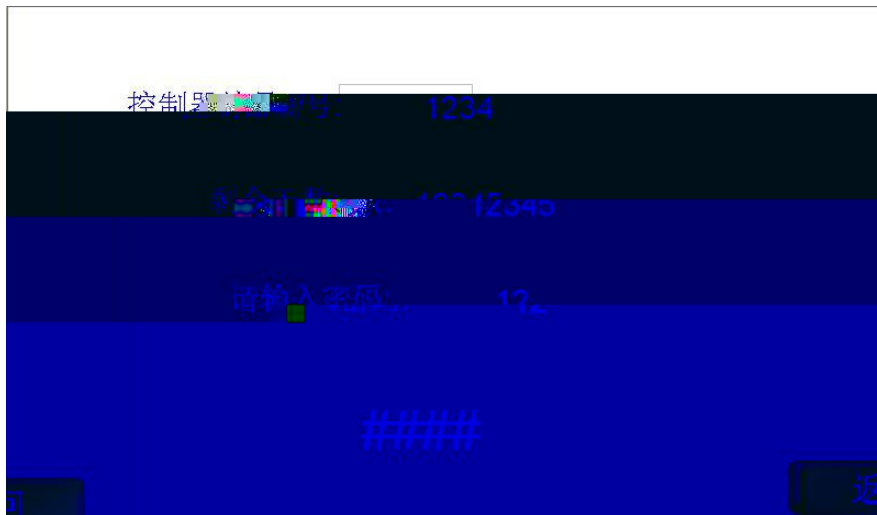

2-16

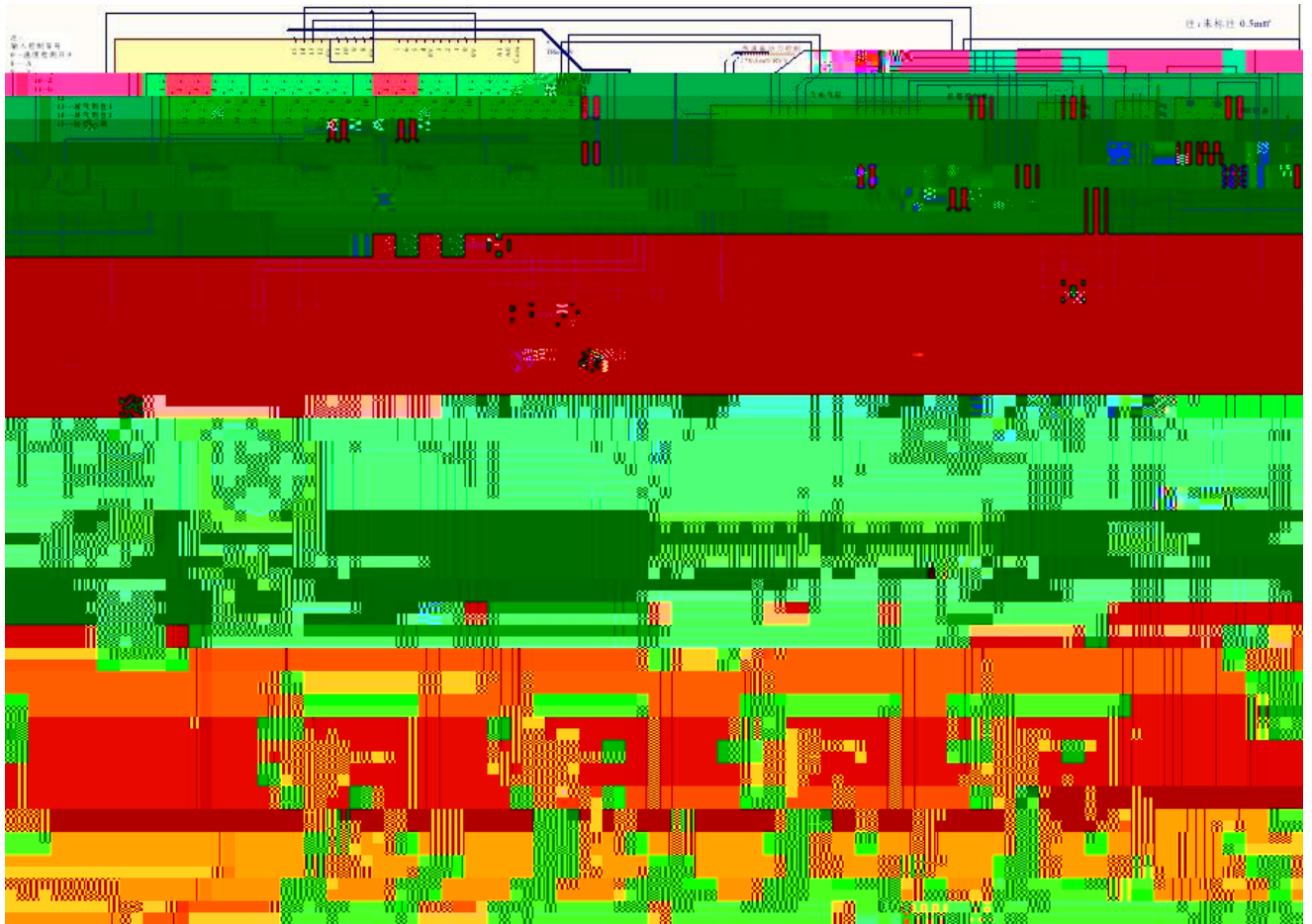

220V/ 380V, 15KW





F>A 77\$' !%) %* F>A 77\$' !% , F>A 77\$' !&) %* F>A 77\$' !&) %,

* \$\$!!%\$\$\$a a #g





S

U
U1
X
Y

U
U1

U
U1

V-Cut

V-Cut

V-Cut
V-Cut

V-Cut

X
Y

U X
U Y

U1 X
U1 Y
X
Y

U

U1

